









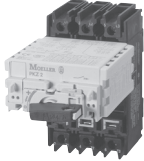

PKZ2 Manual Motor Controllers Overview

Device	Description	Range	Pages	Device	Description	Range	Pages
Manual Motor Controllers				Releases			
	With Interchangeable Trip Module	0.4 – 42 Amps	C48 – C49		Shunt Release	24 – 250 V DC 24 – 600 V AC	C54
	Main Switch Component	–	C50		Undervoltage Release	24 V DC 48 V DC 24 – 440 V AC	C54
	Trip Module Components	0.4 – 42 Amps	C50	Remote Operators			
Auxiliary Contacts					Remote Operator	24 – 240 V DC 24 – 415 V DC	C55
	Side-mounted Standard Auxiliary Contacts	1 NO / 1 NC 2 NO / 2 NC	C53	Accessories			
	Trip-indicating Auxiliary Contacts	1 NO / 1 NC	C53		Miscellaneous Accessories		C56
Current Limiter				Enclosures			
	Current Limiter	$U_e = 690\text{ V}$ to 100 kA / 500 V	$I_u = 40\text{ A}$ C51		Enclosures		C57

- > Interchangeable trip module makes changing tripping characteristics a snap, even after wiring
- > Adjustable thermal *and* magnetic trip settings
- > Overcurrent, short-circuit protection and motor switching functions are combined in one compact unit; all functions are ambient compensated and phase failure sensitive
- > Worldwide approvals, including UL 508/CSA 22.2 No. 14
- > One frame size simplifies engineering and reduces stocking cost

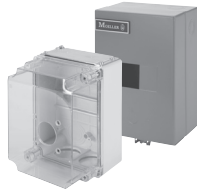
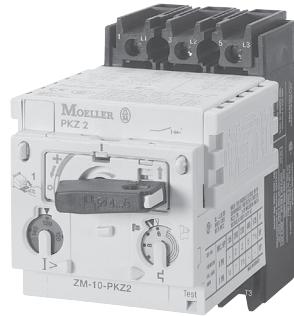

See Next Page for
UL/CSA Application
Ratings Guide

Manual motor controller with adjustable magnetic and thermal standard trip module

UL/CSA Short-circuit current rating kA RMS sym @		Adjustable thermal range set to motor FLC ①	Adjustable trip setting current of magnetic trips ①	"Typical" Maximum Horsepower								Auxiliary Contacts		Catalog Number	Price
				Typical Single Phase [HP]			Typical Three Phase [HP]								
480 V AC	600 V AC	[A]	[A]	115V	200V	240V	200V	240V	480V	600V	NO	NC			
65	42	0.4 – 0.6	5 – 8	<i>See note below</i>								0	0	PKZ2/ZM-0,6	480
65	42	0.6 – 1	8 – 14									0	0	PKZ2/ZM-1	480
65	42	1 – 1.6	14 – 22									0	0	PKZ2/ZM-1,6	488
65	42	1.6 – 2.4	20 – 35									0	0	PKZ2/ZM-2,4	488
65	42	2.4 – 4	35 – 55	1/8	1/4	1/2	1	1	2	3	0	0	PKZ2/ZM-4	488	
65	42	4 – 6	50 – 80	1/4	1/2	1/2	1 1/2	1 1/2	3	5	0	0	PKZ2/ZM-6	488	
65	42	6 – 10	80 – 140	1/2	1	1 1/2	2	3	5	7 1/2	0	0	PKZ2/ZM-10	488	
65	42	10 – 16	130 – 220	1	2	2	3	5	10	10	0	0	PKZ2/ZM-16	488	
65	42	16 – 25	200 – 350	2	3	3	5	7 1/2	20	25	0	0	PKZ2/ZM-25	552	
65	42	24 – 32	275 – 425	2	5	5	10	10	20	–	0	0	PKZ2/ZM-32	680	
65	42	32 – 42	350 – 500	3	5	7 1/2	10	15	30	–	0	0	PKZ2/ZM-40	780	

Horsepower ratings shown in the table are for reference only.
The final selection of the manual starter depends on the actual motor full load current and service factor on the motor nameplate.
Overload should be set at motor FLA full load current and is calibrated to 1.15 S.F. Specified values to NEC table 430-150.

Ordering Instructions

- 1 Determine the motor FLA and Service Factor.
- 2 Use the application rating guide on next page.
- 3 Locate the desired manual motor controller.
- 4 See pages C51 – C56 for auxiliaries and accessories.

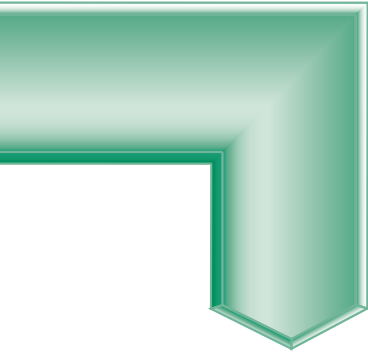

① All types have adjustable dial for setting motor full load current. Trip current is 125% of set value. For motors with a service factor (SF) of 1.0, set dial to 90% of motor full load current.



UL/CSA Application Ratings Guide for PKZ2/ZM

Catalog Number	Maximum short circuit current [kA] when used as . . .						
	Manual Motor Starter			Manual Controller in Group Installation		Max. Fuse [A]	Max. Circuit Breaker [A]
	240V	480V	600V	480V	600V		
PKZ2/ZM-0,6	100	65	42	65	42	500	600
PKZ2/ZM-1	100	65	42	65	42	500	600
PKZ2/ZM-1,6	100	65	42	65	42	500	600
PKZ2/ZM-2,4	100	65	42	65	42	500	600
PKZ2/ZM-4	100	65	42	65	42	500	600
PKZ2/ZM-6	100	65	42	65	42	500	600
PKZ2/ZM-10	100	65	42	65	42	500	600
PKZ2/ZM-16	100	65	42	65	42	500	600
PKZ2/ZM-25	100	65	42	65	42	500	600
PKZ2/ZM-32	100	65	42	65	42	500	600
PKZ2/ZM-40	100	65	42	65	42	500	600

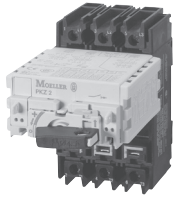
Basic Components

Module	Description	Adjustable thermal range set to motor FLC ① [A]	Adjustable trip setting current of magnetic trips ① [A]	"Typical" Maximum Horsepower				Contacts		For use with...	Catalog Number	Price		
				Typical Three Phase [HP]				NO	NC					
Base Module														
	Maximum continuous motor load current 42A			As per the trip module inserted (see below for selection)				0	0	all other PKZ2 devices	PKZ2	320		
Standard Trip Module														
	Standard trip module for PKZ2 Adjustable thermal and magnetic trips Includes a manual test feature and tamper-preventive settings cover	0.4 – 0.6	5 – 8	<i>see note below</i>				0	0	PKZ2 PKZ2/S-SP	ZM-0,6-PKZ2	160		
		0.6 – 1	8 – 14					½	½		0	0	ZM-1-PKZ2	160
		1 – 1.6	14 – 22					¾	1		0	0	ZM-1,6-PKZ2	168
		1.6 – 2.4	20 – 35	½	½	1	1½	0	0		ZM-2,4-PKZ2	168		
		2.4 – 4	35 – 55	1	1	2	3	0	0		ZM-4-PKZ2	168		
		4 – 6	50 – 80	1½	1½	3	5	0	0		ZM-6-PKZ2	168		
		6 – 10	80 – 140	2	3	5	7½	0	0		ZM-10-PKZ2	168		
		10 – 16	130 – 220	3	5	10	10	0	0		ZM-16-PKZ2	168		
		16 – 25	200 – 350	7½	7½	20	25	0	0		ZM-25-PKZ2	232		
		24 – 32	275 – 425	10	10	20	30	0	0		ZM-32-PKZ2	360		
		32 – 42	350 – 500	10	15	30	30	0	0		ZM-40-PKZ2	460		
		<p>Horsepower ratings shown in the table are for reference only. The final selection of the manual starter depends on the actual motor full load current and service factor on the motor nameplate. Overload should be set at motor FLA full load current and is calibrated to 1.15 S.F. Specified values to NEC table 430-150.</p>												

Manual Motor Controllers

Ordering Instructions

- 1 Determine the motor FLA and Service Factor.
- 2 Locate the desired trip module.
- 3 Order trip module and base module separately.
- 4 See pages C51 – C56 for auxiliaries and accessories.

① All types have adjustable dial for setting motor full load current. Trip current is 125% of set value. For motors with a service factor (SF) of 1.0, set dial to 90% of motor full load current.

Current Limiter ①

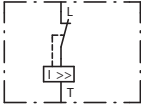
Module	Description	Schematic	For use with...	Catalog Number	Price
Current Limiter					
	<p>Max. rated operational voltage $U_e = 690\text{ V}$</p> <p>Rated uninterrupted current $I_u = 40\text{ A}$</p> <p>Can be fitted to controller with mounting plate C-PKZ2, or can be fitted individually with mounting base EZ-PKZ2</p> <p>See page C65 for capacity ratings</p>		PKZ2 PKZ2/ZM	CL-PKZ2	436

Tamper-preventive coding pins ②

Accessory	Description	For use with...	Catalog Number	Price
Coding Pins				
	<p>Tamper-preventive feature used to pair proper trip module with base module.</p> <p>Once inserted, coding pins are not removable.</p> <p>Deters tampering or an accidental incorrect insertion during maintenance.</p> <p>Unique coding for up to 6 different trip modules.</p>	PKZ2 + ZM	CS-PKZ2	6.90

Easy to use Coding Pins

Just snap pins off into intended slots ②

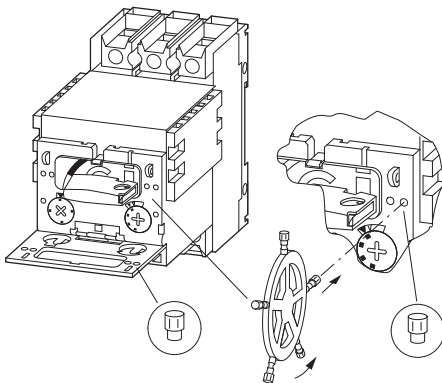

Example of unique coding for up to 6 different trip modules

(see diagram on right)

If you have this controller (examples)	Code the base module		Then code all trip modules of this type with same coding	
	Base module	Break off pins in slots on	Trip module from example	Break off pins in slots on
PKZ2/ZM-0,6	PKZ2	C, D	ZM-0,6-PKZ2	1, 2
PKZ2/ZM-1	PKZ2	B, D	ZM-1-PKZ2	1, 3
PKZ2/ZM-1,6	PKZ2	B, C	ZM-1,6-PKZ2	1, 4
PKZ2/ZM-2,4	PKZ2	A, D	ZM-2,4-PKZ2	2, 3
PKZ2/ZM-4	PKZ2	A, C	ZM-4-PKZ2	2, 4
PKZ2/ZM-6	PKZ2	A, B	ZM-6-PKZ2	3, 4

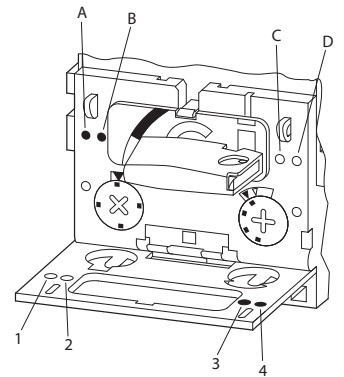

① Device is not approved by UL or CSA.

② Once inserted, coding pins are not removable.